



Valentina collection

KITE RANGE

SLT978EMELBK

930MM OFFBOARD CEILING CASSETTE
WITH BLACK TRIM & A LIGHT PENDANT

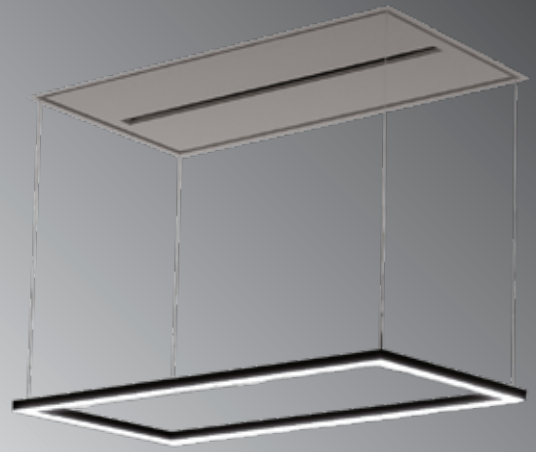

SPECIFICATIONS

Rangehood Type	Ceiling Cassette
GTIN	9351116000431
Country of Origin	Hand-Crafted in Italy
Suits Cooktop Size	up to 900mm
Suits Cooktop Style	Induction, Gas, Electric
Recommended Install Height	min 1200 to max 1800mm from cooktop surface
Finish	White Powdercoated Stainless Steel & Light Bar
Controls	WiFi with Voice & App Control + Remote Control
Speed Settings	4 (3 + Booster)
Recirculating	Optional
Extraction Rate [#]	1200m ³ /h
Filter Type	Aluminium Mesh
Noise Level*	approx. 60dBA to 70dBA
Lighting	11W Dynamic Lighting
Run-on Timer	Yes - 10mins
Automatic Shut-Off	Yes - 4hrs
Electrical Requirement	10AMP
Max Current (W)	511W
Motor Options	Offboard SEM11, SEM21 or SEM51
Ducting Options	Sides
Ducting Size	220mm x 90mm Rectangular (150mm circular ducting with rectangular to circular adaptor)
Product Dimensions (mm)	W930 x D440 x H200 NB: Light extends down upto 1200mm
Nett Weight	29kg
Carton Dimensions (mm)	W950 x D700 x H450
Gross Weight	32kg
Warranty	3 Years - 6 Years if paired with Sirius Ducting
Energy Rating [^]	C
kWh/Annum [^]	approx. 85 dependent on motor

LINE DRAWING

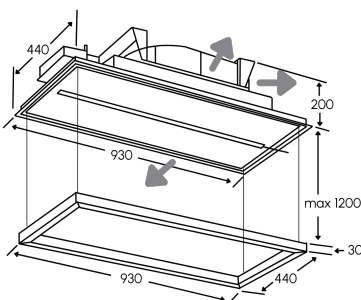

Approx. Cut-out Dimensions
W910 x D420mm

Dimensions include trim.
Allows extra for ease of installation.
See user manual for more information

KEY FEATURES



Offboard Green Energy Motor

Our revolutionary technology paired with advanced engineering generates greater air movement with less fan movement, creating a superior cooking environment.



Powerful Airflow

With impressive airflow and control, this rangehood quickly and effectively removes smoke, steam, heat, odours, and other airborne particles from the kitchen. Conveniently controlled with 4 speed settings.



Dynamic Lighting

Adjust the lighting to suit your needs with our Dynamic Lighting System (DLS) with the flexibility to match the rooms lighting by adjusting the Kelvin between 2700 to 6500 or dim to set the mood. Also adjustable with the Sirius App.



Remote Control

This rangehood comes with a convenient remote control, giving you the ability to operate the hood from a distance. Designed to be simple and intuitive, it allows you to effortlessly adjust the fan speed, lighting, timer settings and built-in features at an easy touch of a button.



WiFi Enabled

WiFi enabled to allow you to use it with our Sirius App and Voice Activation with Google and Alexa. Control your hood with a few simple commands, manage your extraction power, lighting and built in features.



Induction Suited

This rangehood has the sufficient extraction required to facilitate induction cooking. As induction cooking uses the base of the pan as the heat source, less moisture and steam is evaporated before it reaches the filters. This can create drops of water that drip into your cooking.



Mesh Filter

Our mesh filters are made to ensure superior durability and filtration performance. Trapping grease, oils, smoke and odours during cooking, their design also helps reduce possible fire hazards. Eco-friendly, cost-effective, easy to install and easy to clean in the dishwasher.



Recirculated Option

Recirculating your rangehood filters the air and blows it back into the room, and often requires a carbon or charcoal filter to help clean the air. This is a good option for small spaces or if you can't duct to the outside atmosphere.



Hand-Crafted in Italy

Pioneering downdrafts since 2001, Sirius were the first to introduce this innovative rangehood. Quality, functionality, innovation, style & luxury hand-crafted in Italy. Leading the market in design and functionality, this collection has been specifically handpicked for Australian living.

[#]Extraction rate is an approximate figure and varies depending on installation.

^{*}Note noise level is an approximate range and subject to installation and surrounding materials.

[^]Product is manufactured in Italy, ratings are based on European directive 65/2014 regulations.

This information is correct at time of producing and subject to change as products develop. Always check the physical product before making any cut-outs or installing.

For more information, visit our website.



Valentina collection

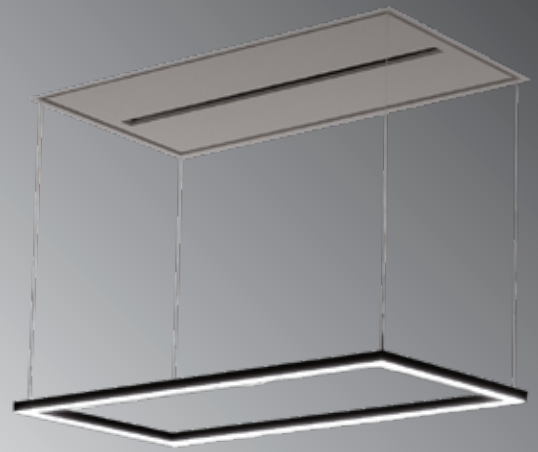

KITE RANGE

SLT978EMELBK

930MM OFFBOARD CEILING CASSETTE
WITH BLACK TRIM & A LIGHT PENDANT

DUCTING OPTIONS

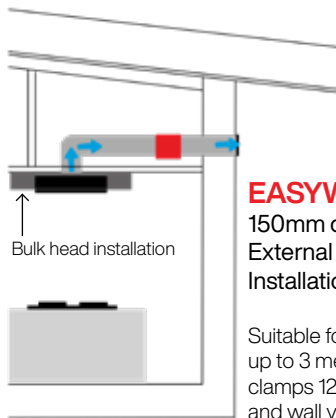

EASYWALLKIT 150mm diameter External Wall Installations

Suitable for duct runs of up to 3 metres, semi rigid, clamps 125/150 expander and wall vent include.

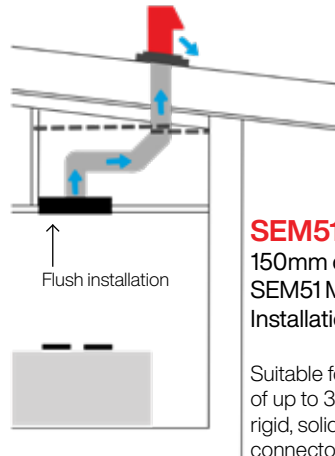

SEM51KIT 150mm diameter SEM51 Motor Installations

Suitable for duct runs of up to 3 metres, semi rigid, solid duct, internal connectors, clamps, flashing, bracing straps, 125/150 expander for SEM5 or SEM51 Motors.

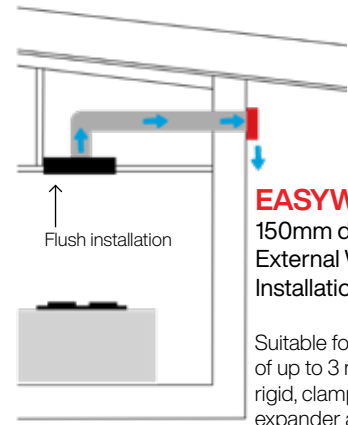

EASYWALLKIT 150mm diameter External Wall Installations

Suitable for duct runs of up to 3 metres, semi rigid, clamps 125/150 expander and wall vent include.

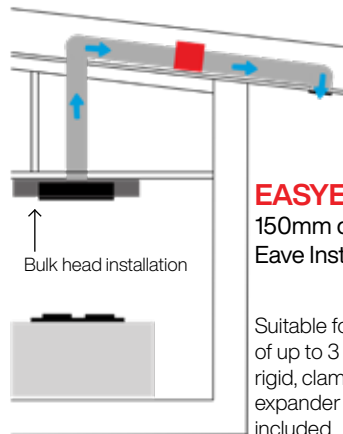

EASYEAVEKIT 150mm diameter Eave Installations

Suitable for duct runs of up to 3 metres, semi rigid, clamps 125/150 expander and eave vent included.

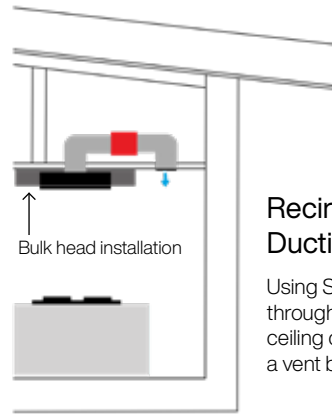

Recirculated Ducting

Using SEM11, duct through the bulk head or ceiling cavity and through a vent back into the room.

6 Year Warranty

when Sirius ducting is used

Sirius has its own range of ducting kits and components, designed to get the most power and efficiency out of its hoods. The full range of high quality, cost effective ducting kits and individual parts will provide you with the best result for your rangehood.

All EasyKits can be extended with 1 set (2) Universal Ring Clamps (URC25-215) and 1 x Semi Rigid Duct length (SRPRO30-150) that expands upto 3 metres.

Visit our website for more information on Sirius Rangehoods, SEM Motors and Sirius Ducting and EasyKits

